

Push PIN

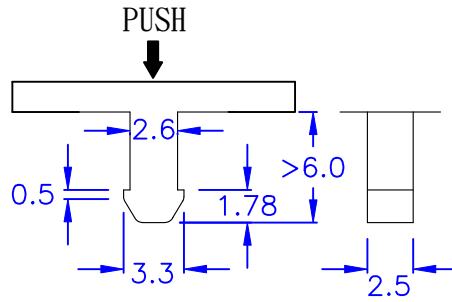

◎ HOLE IN CHASSIS:

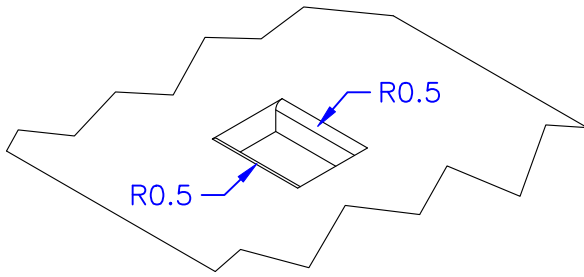
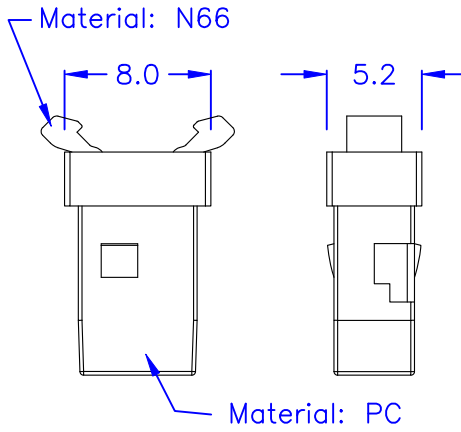
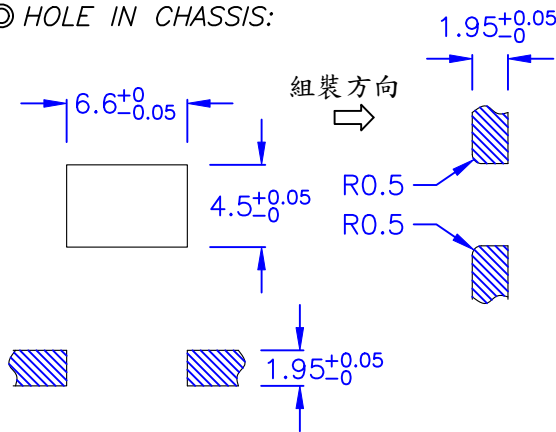

◎ CHASSIS THICKNESS: $1.95+0.05$ mm

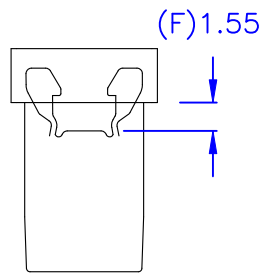

Maximum Push-IN Position
夾子欲下壓產生扣住功能時，行程距離卡板頂端距離 F 為 1.55mm。

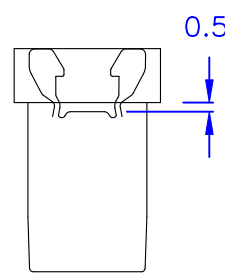

CLOSE Position LOCK
夾子扣住時夾子頂端位置距離卡板頂端 0.5mm

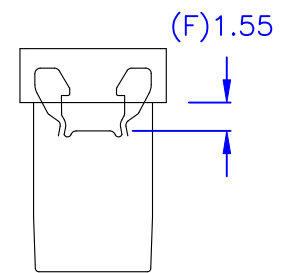

Maximum Push-out Position UNLOCK
夾子欲下壓產生解除扣住功能時，行程距離卡板頂端距離 F 為 1.55mm。

◎常溫耐久承受力 0.8 kg

DRAW NO. PGAS035854

GJS

PLASTIC TOLERANCE:	
$L \leq 10$	± 0.2
$10 < L \leq 30$	± 0.3
$30 < L \leq 50$	± 0.5
$50 < L \leq 100$	± 0.7
$100 < L \leq 250$	± 1.2
ABOVE 250	± 1.5

網頁圖示供參考，最終以品固公司正式圖面為主
The plastic tolerance is just for your reference; all the measurements and dimensions are according to the "DATA SHEET" issued by PINGOOD.



品固企業股份有限公司
品基電子(東莞)有限公司
蘇州品基電子科技有限公司
東莞市鈺隆商貿有限公司
鑽隆有限公司
PINGOOD ENTERPRISE CO.,LTD.

外殼材質: PC V2 or EQUIVALENT

夾子材質: N66 V0 or EQUIVALENT

COLOR: BLACK

PART NAME:

門扣
PUSH LATCH

PART NO:

DL-220C

A

SIZE

VERSION

2A

SHEET 1 OF 1

	UNIT	SCALE
	mm	

表單號碼 QF135