

◎ HOLE IN DIMENSIONS: $\phi 4.5$
 ◎ CHASSIS THICKNESS: 1.4~1.6 mm

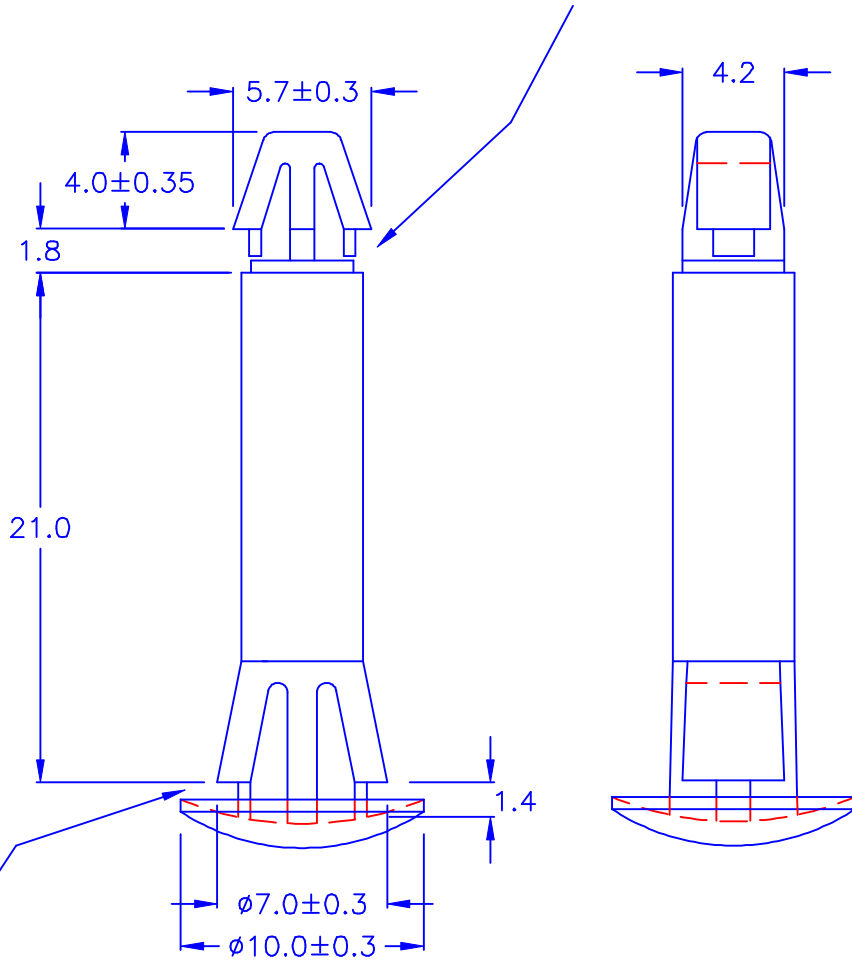

◎ HOLE IN DIMENSIONS: $\phi 5.5$
 ◎ CHASSIS THICKNESS: 0.8~1.0 mm

◎ Halogen Free 低鹵
 ◎ ROHS 2.0
 ◎ ROHS 六項 compliant

DRAW NO. PGAS022310

GJS

PLASTIC TOLERANCE:

$L \leq 10$	± 0.2
$10 < L \leq 30$	± 0.3
$30 < L \leq 50$	± 0.5
$50 < L \leq 100$	± 0.7
$100 < L \leq 250$	± 1.2
ABOVE 250	± 1.5

網頁圖示供參考,最終以品固公司正式圖面為主
 The plastic tolerance is just for your reference; all the measurements and dimensions are according to the "DATA SHEET" issued by PINGOOD.

MATERIAL: N66 V2 or EQUIVALENT

COLOR: NATURAL



品固企業股份有限公司
 品基電子(東莞)有限公司
 蘇州品基電子科技有限公司
 鑽隆有限公司
 PINGOOD ENTERPRISE CO.,LTD.

PART NAME:

P.C. 板間隔柱
 SPACER SUPPORT

A
 SIZE

VERSION
 2B

PART NO:

SCC-21

SHEET 1 OF 1



UNIT	SCALE
mm	